

---

**FSA**

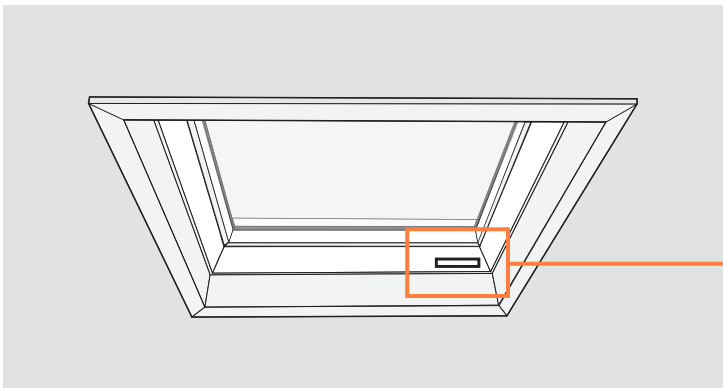

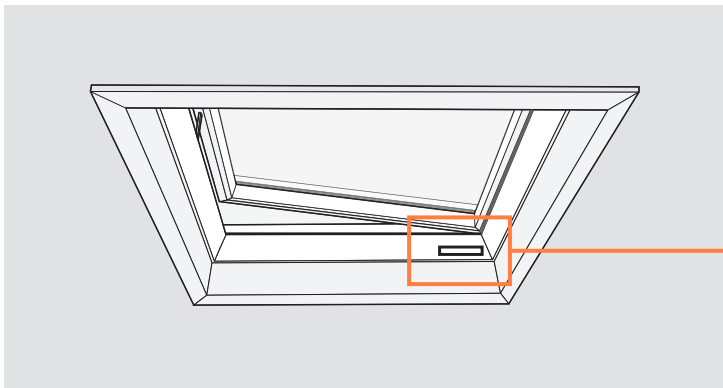

# FRE

EN 15253-1-2012  
CE EN 15253-1  
EN 1873:2005  
FRE XXXXXX XXXXXX  
XXXXXX  
XXXXXXX



**4-16**

# FRF

EN 15253-1-2012  
CE EN 15253-1  
EN 1873:2005  
FRF XXXXXX XXXXXX  
XXXXXX  
XXXXXXX



**17-27**

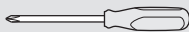
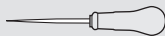
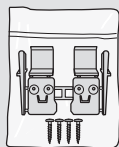
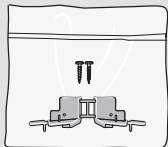
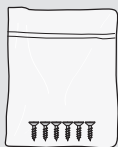
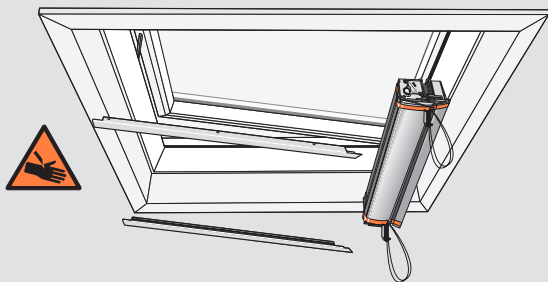

1

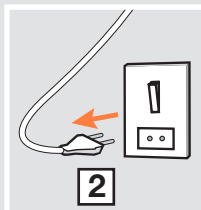
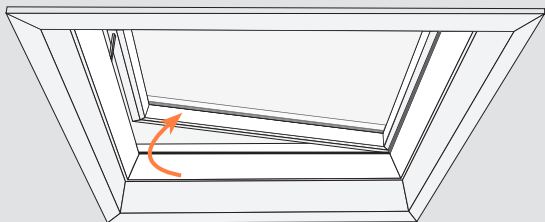

2

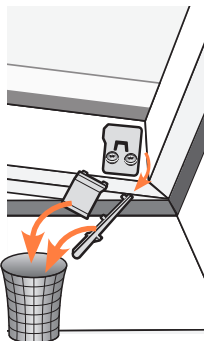
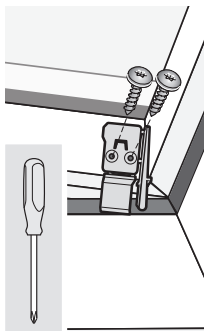
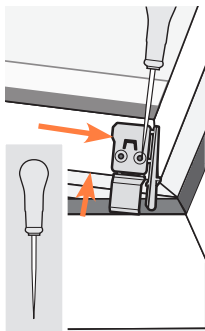
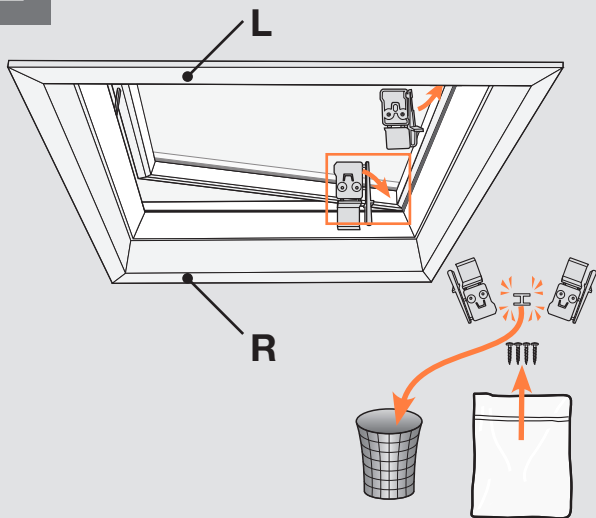

3

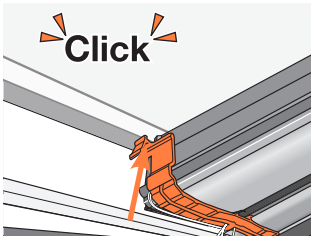
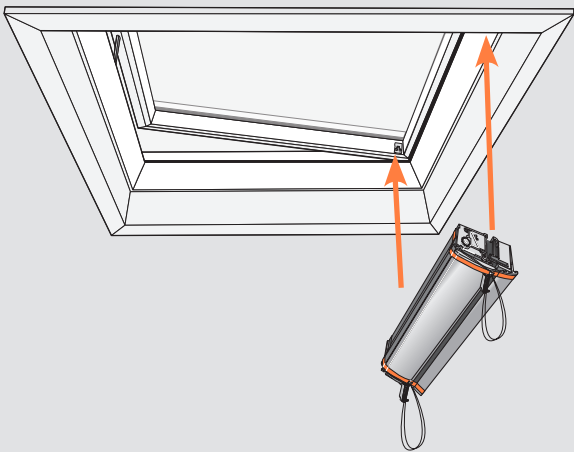

4

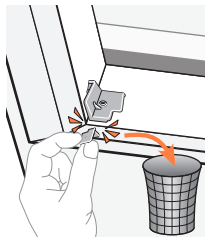
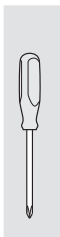
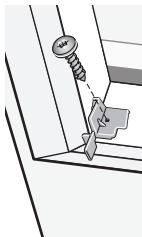
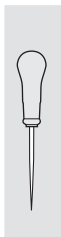
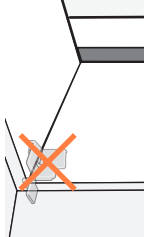
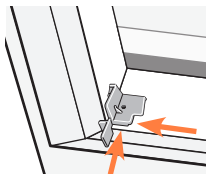
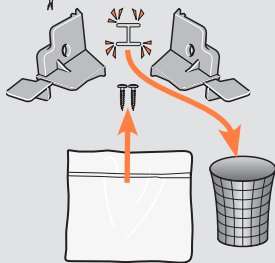
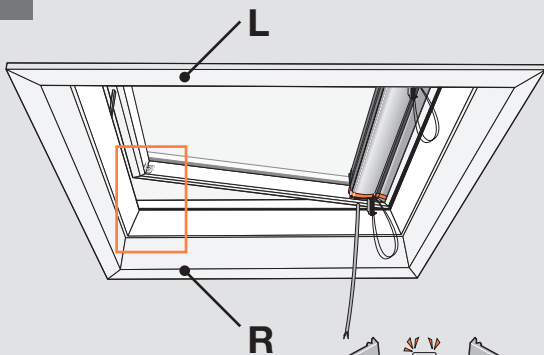



5

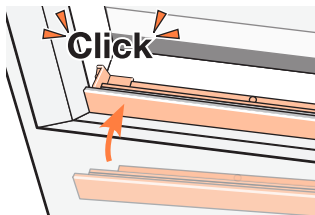
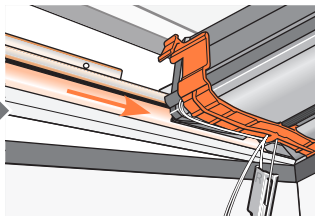
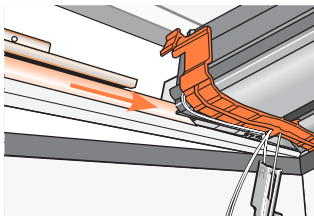
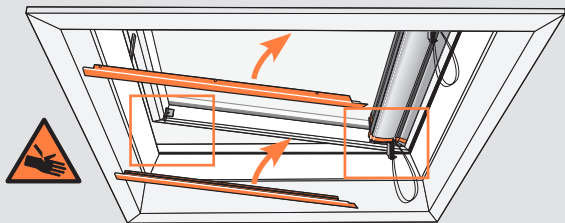

6

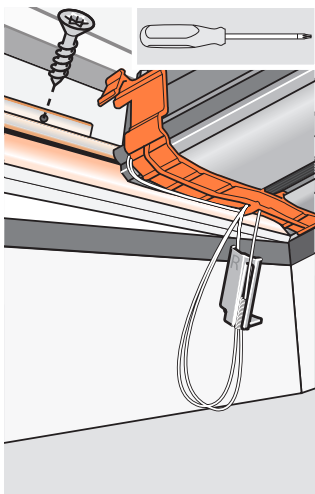
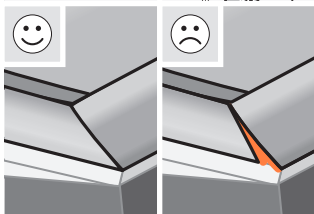
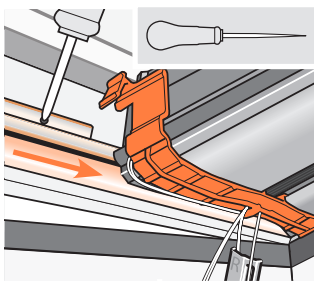
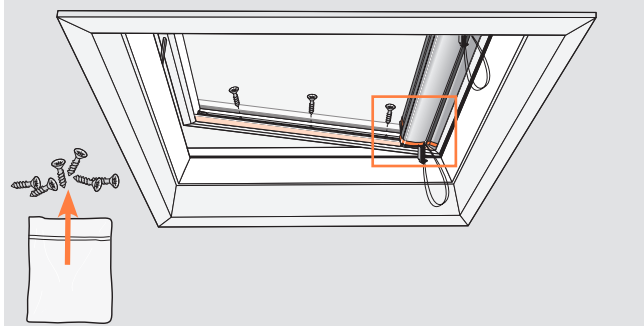

7

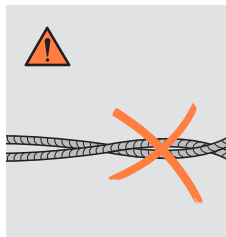
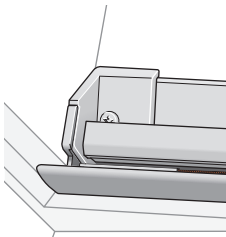
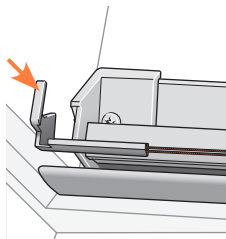
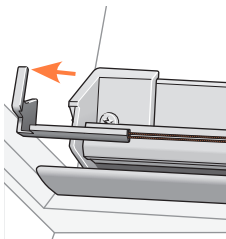
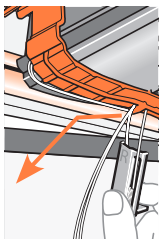
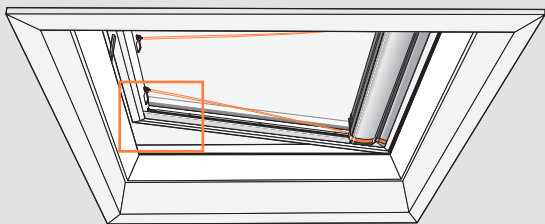

8

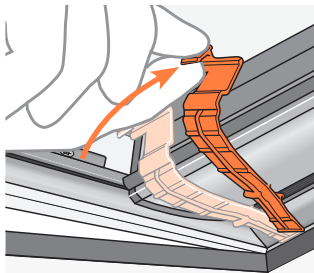
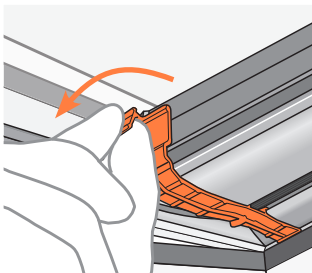
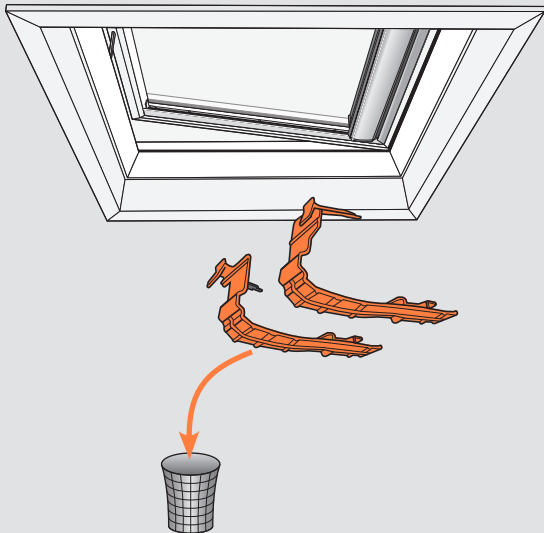

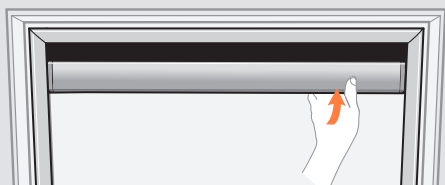
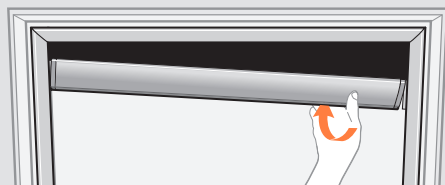
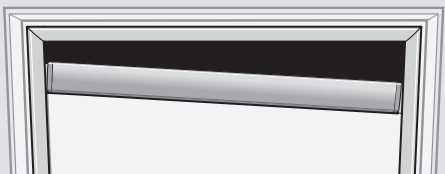
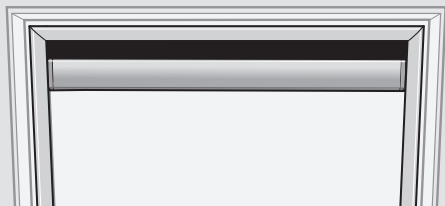

9

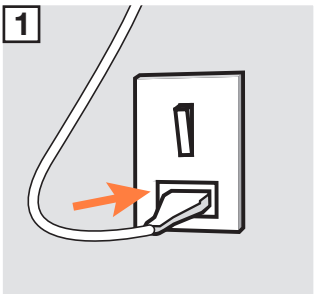
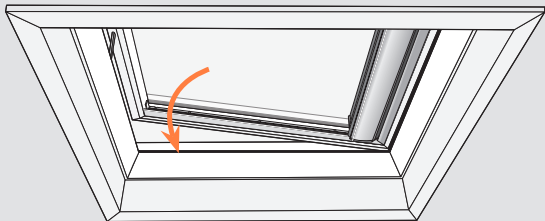

10

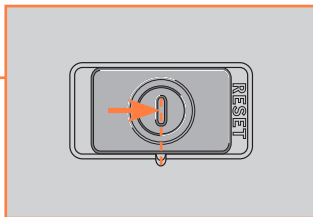
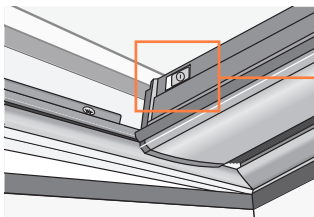
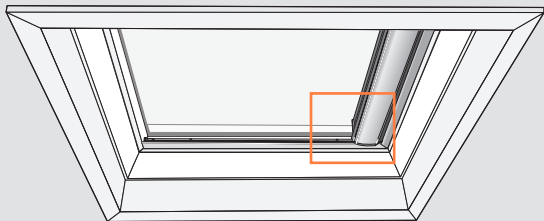

11

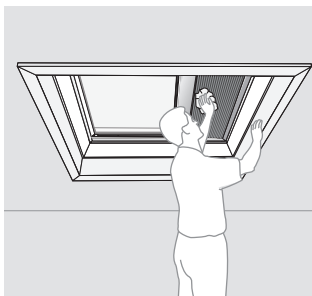
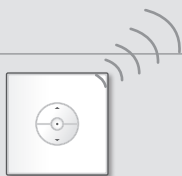
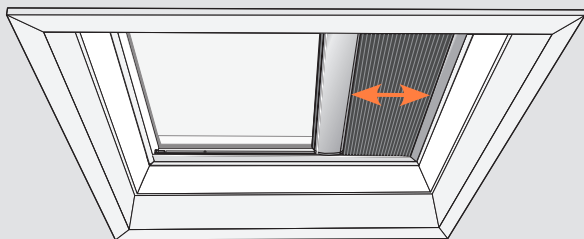



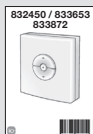
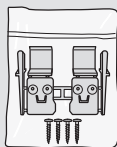
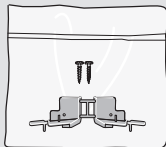
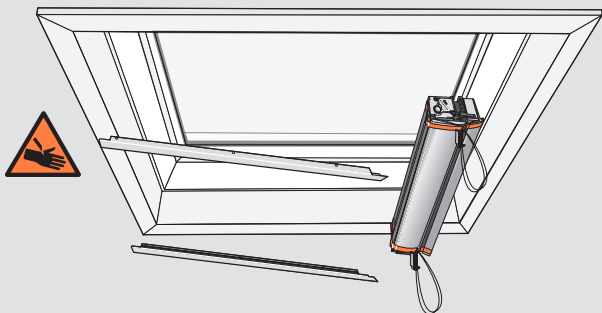

1

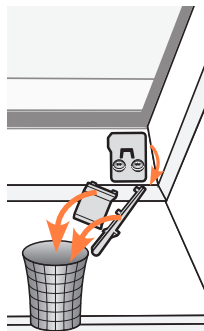
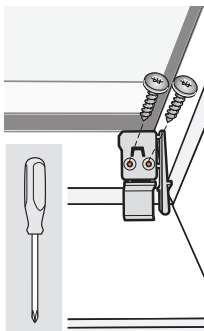
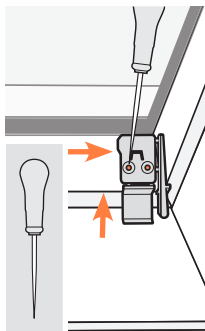
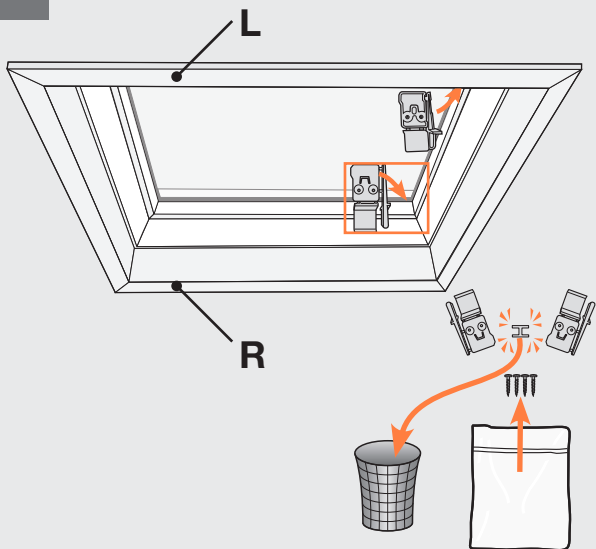

2

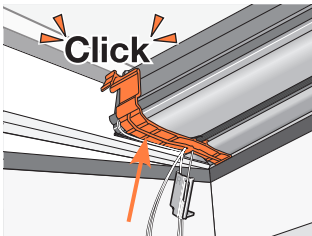
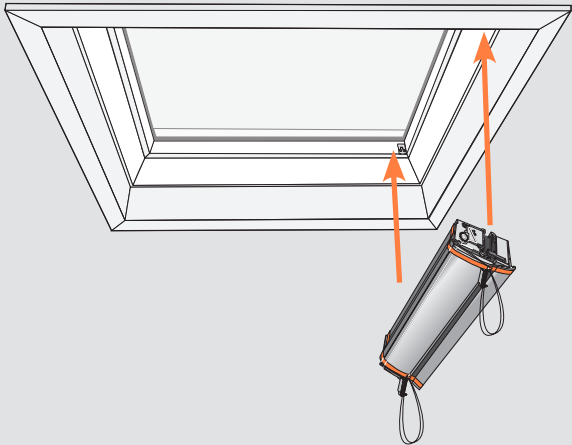

3

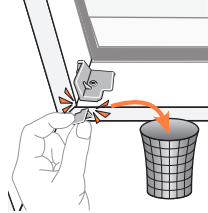
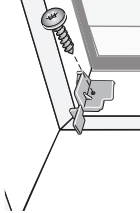
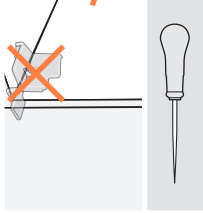
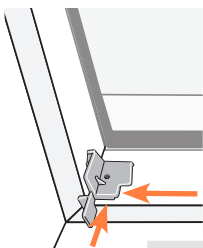
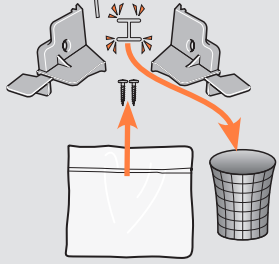
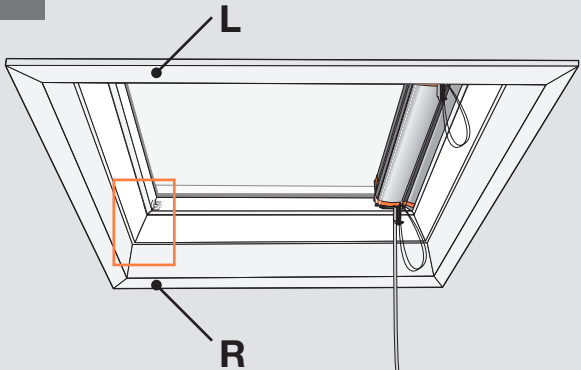

4

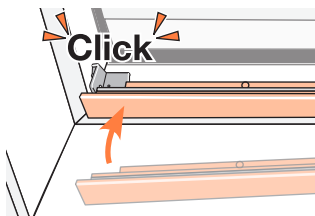
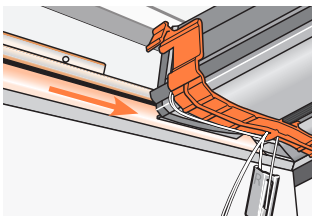
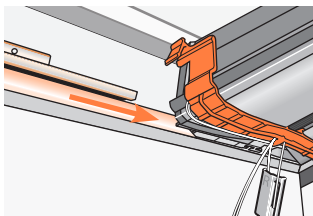
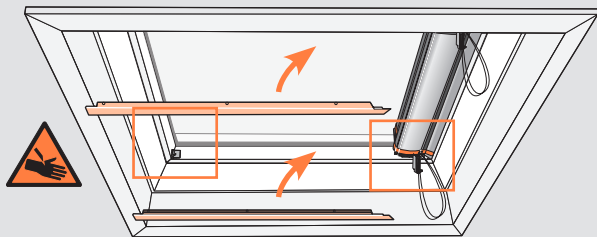

5

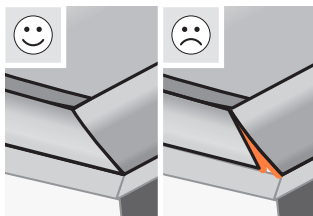
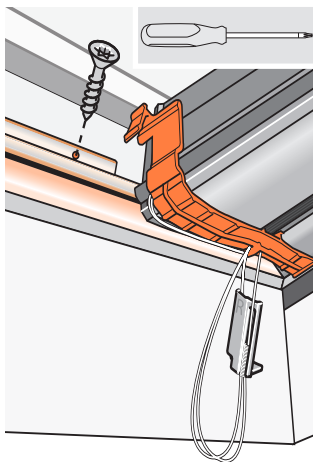
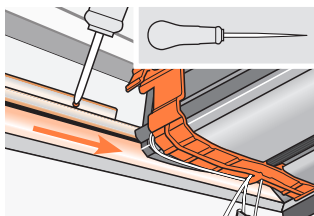
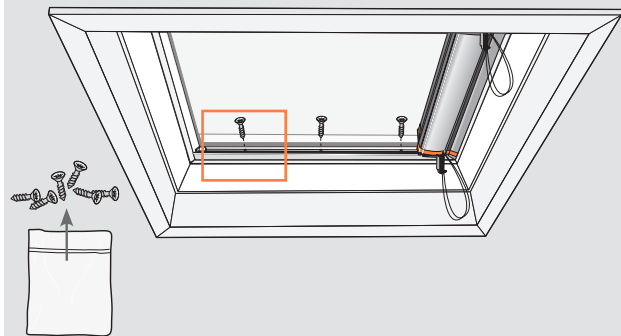

6

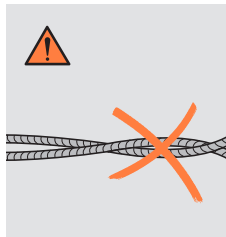
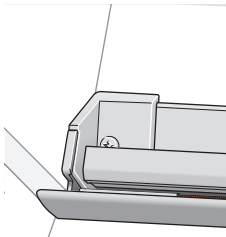
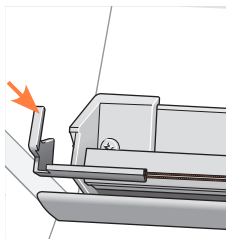
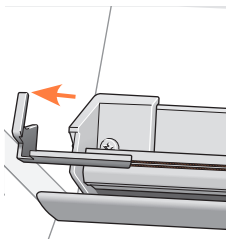
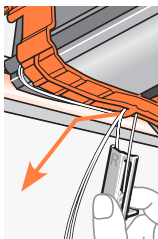
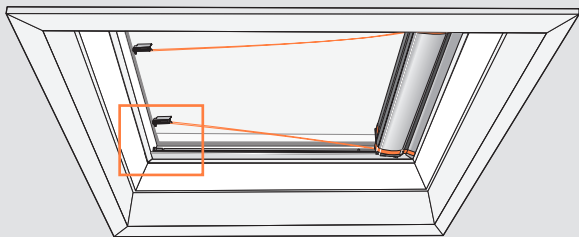

7

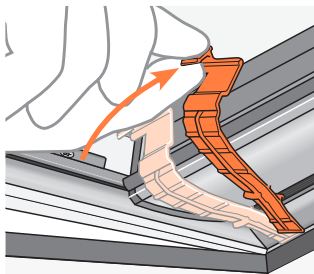
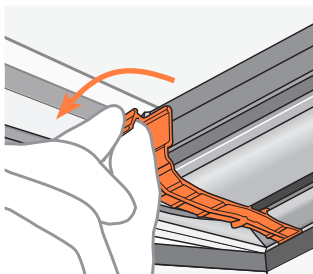
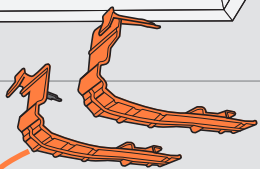
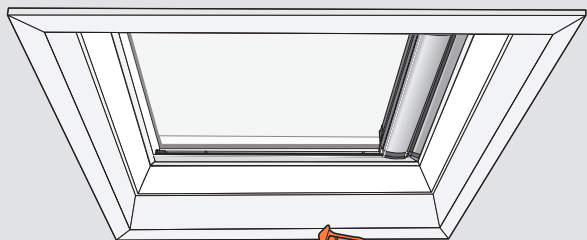



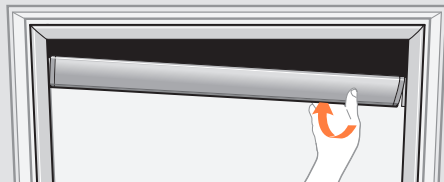
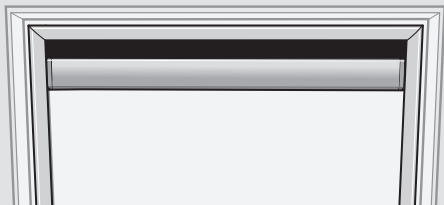

8

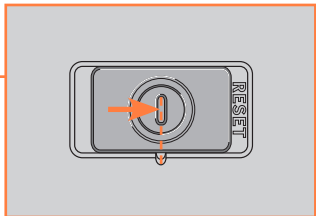
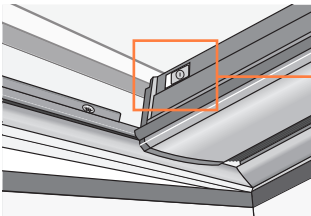
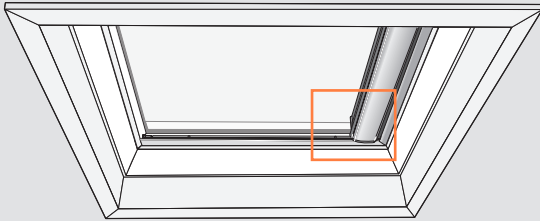

9

